

# Design for Galvanizing



Download from the App Store and Google Play. Search 'Design Guide for Hot Dip Galvanizing - best practice for venting and draining'

**galvanizers**  
ASSOCIATION OF AUSTRALIA

03 9654 1266  
gaa@gaa.com.au  
gaa.com.au

## Using Hot-Rolled Sections

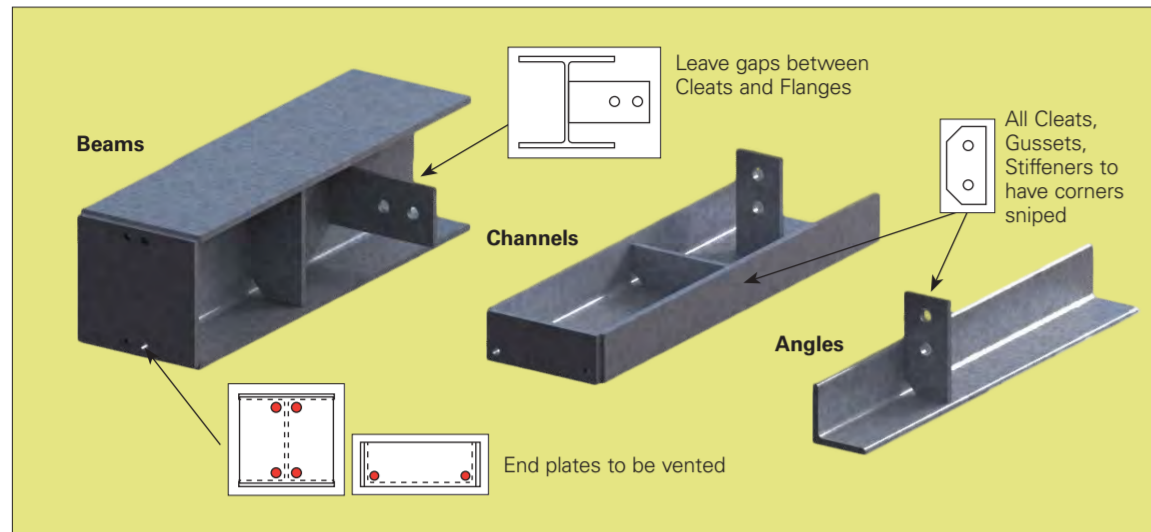

## Using Hollow Sections

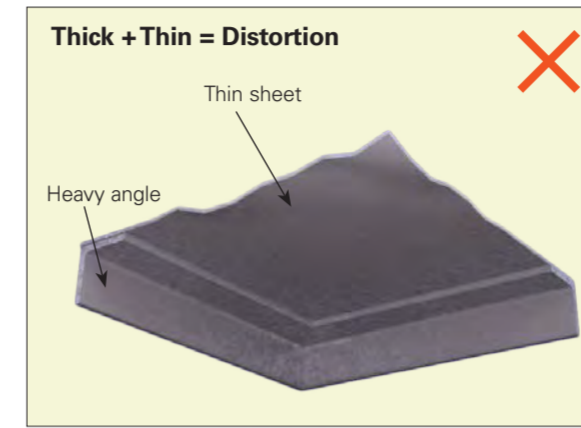
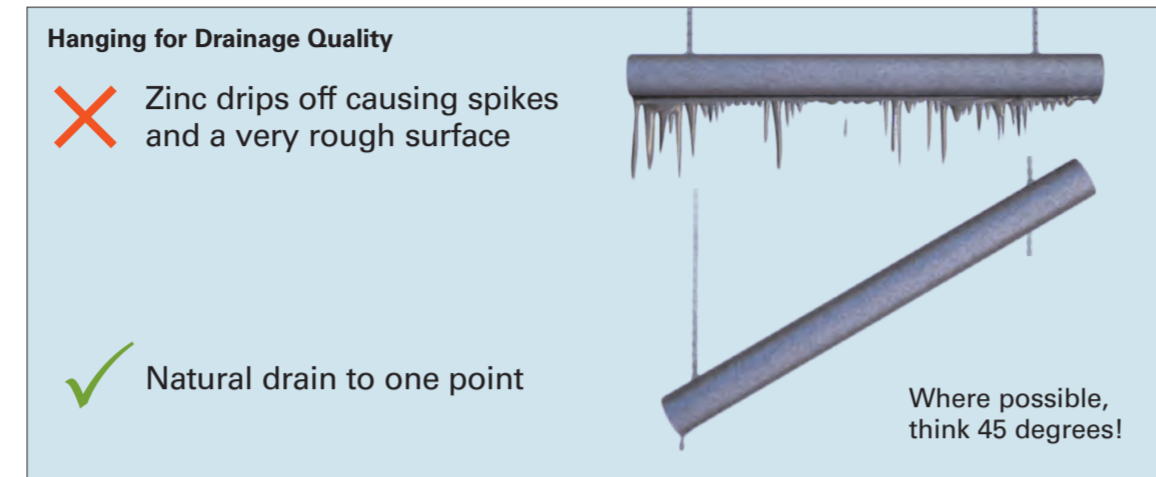

## Avoiding Distortion – Basic Design Rules

- 1) Maximise the uniformity of heat transfer into and out of the steel.
  - a. Ensure venting and draining is adequate. This will allow the article to be immersed in and withdrawn from the molten zinc as quickly as possible.
  - b. Minimise section thickness variations wherever possible in the fabrication.
- 2) Minimise the effect of stresses while the article is in the molten zinc.
  - a. Use symmetrically rolled sections in preference to angle or channel frames. I-beams are preferred to angles or channels.
  - b. Ensure assembly and welding techniques minimise stresses in components making up the article.
- 3) Avoid designs that require double dipping. It is preferable to build assemblies and sub-assemblies in suitable modules allowing for quick immersion and galvanizing in a single dip so the entire article can expand and contract uniformly.
- 4) Ensure the structural design of the item is sufficient to support its own weight at 50% of the steel's specified yield strength.
- 5) Avoid using large areas of thin (under 8mm), unbraced flat plate.
- 6) Use temporary bracing or reinforcing on thin-walled and asymmetrical designs.

## Overlapping Sections

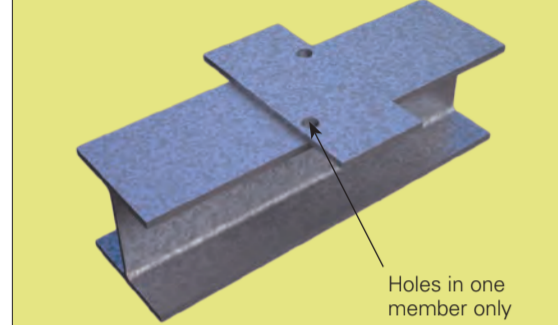

### General Rules for Overlapping Surfaces:

- a. Overlapping surface areas under 10,000mm<sup>2</sup> generally do not require venting.
- b. Overlapping surface areas between 10,000mm<sup>2</sup> and 40,000mm<sup>2</sup> shall be vented with a minimum Ø10mm vent hole.
- c. Above 40,000mm<sup>2</sup> in overlapping surface area, the vent holes shall be minimum Ø12mm.
- d. When the overlapped surface area reaches 250,000mm<sup>2</sup>, vent holes shall be minimum Ø20mm and progressively placed every 250,000 mm<sup>2</sup>.

For designs with intermittent welds the space between overlapping surfaces of two components shall be at least 2.5mm.

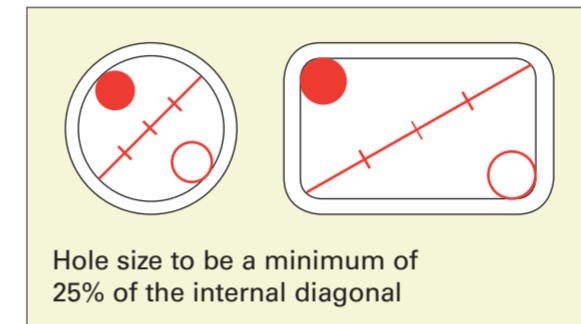
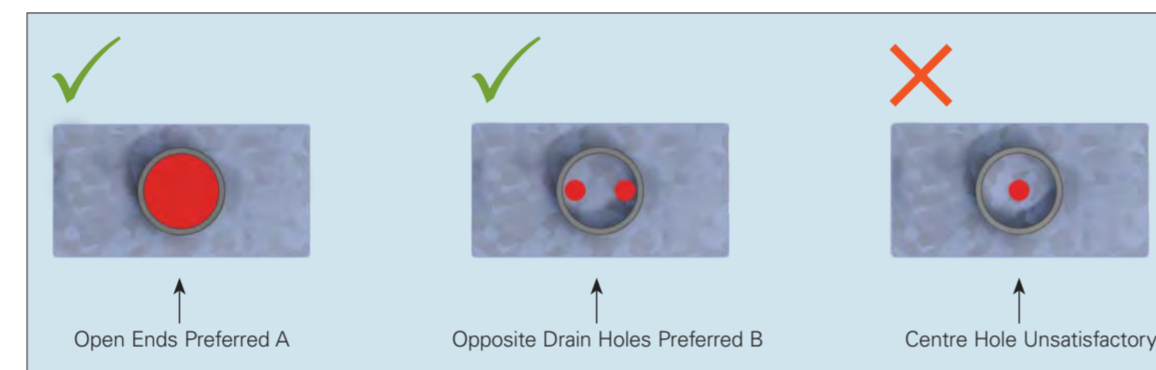
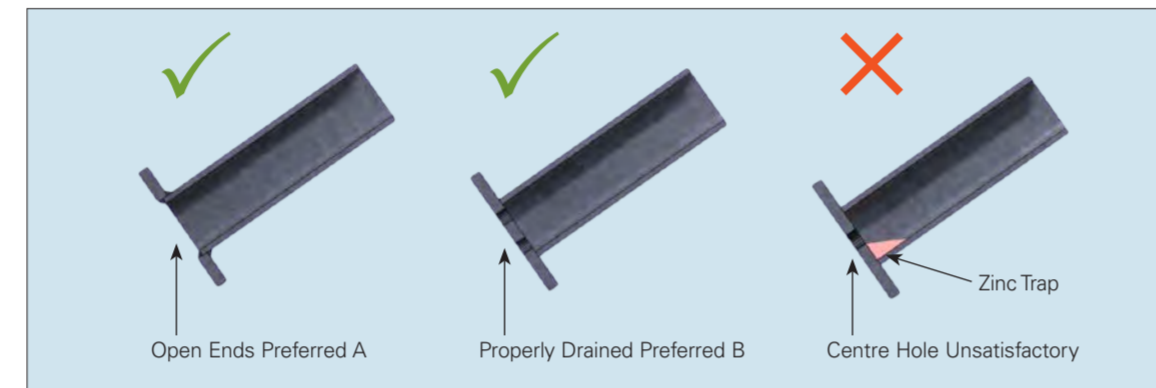
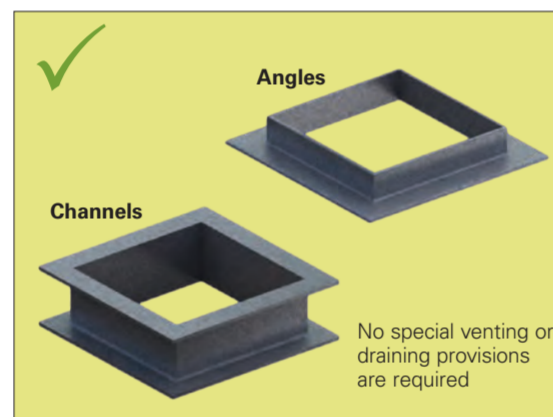
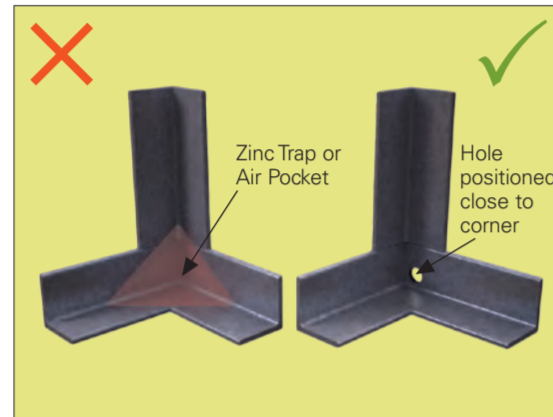

## Moving Parts – Swinging Gate

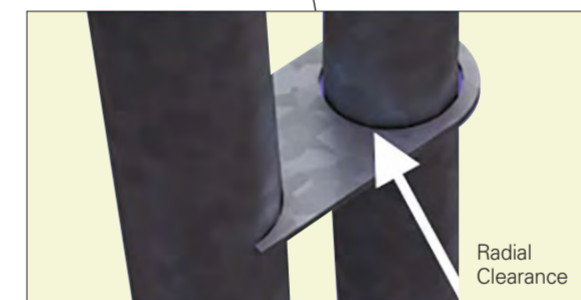
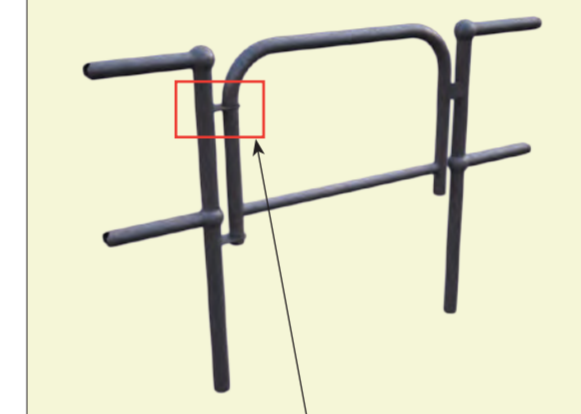

## Recommended minimum radial clearance before galvanizing

Shaft or spindle size (mm)	Minimum radial clearance (mm)
< Ø10	1.0
≥ Ø10 to ≤ Ø30	2.0
> Ø30	2.5

Note: Some fettling may be required after galvanizing to enable parts to be free moving.

## Standard Hole Sizes

NB	Outside Diameter Ø (mm)	CHS/Pipe			SHS			RHS				
		1 Hole Ø (mm)	2 Holes Ø (mm)	4 Holes Ø (mm)	A x B (mm)	1 Hole Ø (mm)	2 Holes Ø (mm)	4 Holes Ø (mm)	A x B (mm)	1 Hole Ø (mm)	2 Holes Ø (mm)	4 Holes Ø (mm)
20	26.9	10	10	10	20 x 20	10	10	10	50 x 25	14	10	10
25	33.7	10	10	10	25 x 25	10	10	10	65 x 35	18	13	10
32	42.4	11	10	10	30 x 30	11	10	10	75 x 25	20	14	10
40	48.3	12	10	10	35 x 35	12	10	10	75 x 50	25	16	11
50	60.3	15	11	10	40 x 40	14	10	10	100 x 50	30	20	14
65	76.1	19	13	10	50 x 50	18	13	10	125 x 75	40	30	18
80	88.9	22	16	11	65 x 65	25	16	11	150 x 50	40	30	20
90	101.6	25	18	13	75 x 75	25	19	13	150 x 100	45	35	25
100	114.4	30	20	14	89 x 89	35	22	16	200 x 100	60	40	30
125	139.7	35	25	17	90 x 90	35	25	16	250 x 150	75	55	40
150	165.1	45	30	22	100 x 100	35	25	18	300 x 200	90	65	45
	168.3	45	30	22	125 x 125	45	35	22	350 x 250	110	80	55
	219.1	55	40	30	150 x 150	55	40	30	400 x 200	115	80	60
	273.1	70	50	35	200 x 200	75	50	35	400 x 300	125	90	65
	323.9	85	60	40	250 x 250	90	65	45				
	355.6	90	65	45	300 x 300	110	75	55				
	406.4	105	75	55	350 x 350	125	90	65				
	457	115	85	60	400 x 400	145	100	75				
	508	130	90	65								

Note: '1 hole', '2 holes' and '4 holes' means the number of holes in each otherwise unopen end.

## Large Overlapping Areas

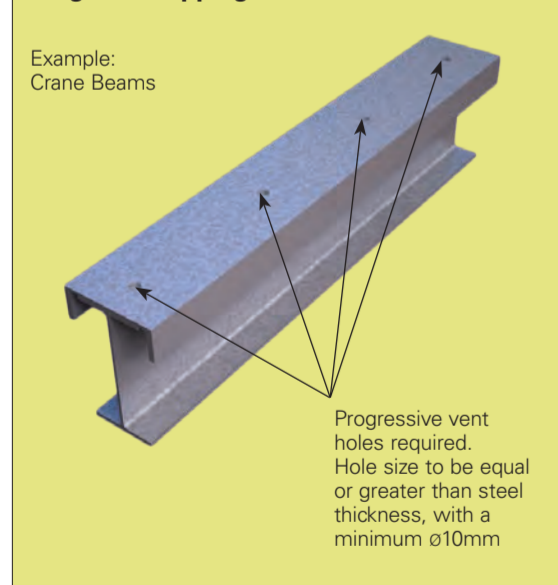

### Snipe Guide

Nominal Section	Snipe Size (mm)
PFC 150 to 250 above 250	25x25 30x30
Angle 100 to 150 above 150	25x25 30x30
UB up to 250 above 250	25x25 30x30
UC up to 200 above 200	25x25 30x30

(For the smaller sections, a hole is the more preferred option for venting)

## Identification Markings



- ### Permanent identification
- Recommended methods are:
- Heavily embossed markings
  - Punched markings
  - Welded markings
- ### Temporary identification
- Before and after galvanizing: recommend use of heavily embossed metal tags, generally attached to the article via wire.
- Only before galvanizing: recommend water-based paints/markings pens.
- ### Identification methods not acceptable:
- Oil-based paints/markings pens
  - Stickers

## Purpose of Venting and Draining

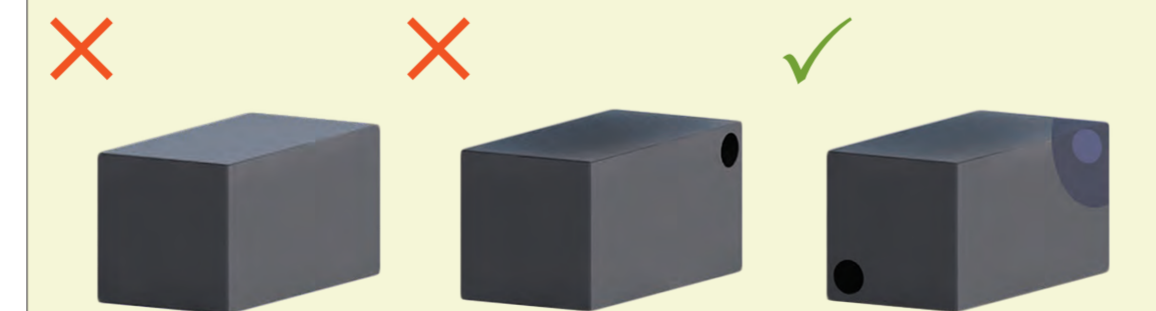

### Hole Position

- Holes should be placed as close to corners and/or connections as practical.
- Holes must be located as close to the high and low points of hollow sections as possible to prevent air locks, entrapment of pre-treatment chemicals and zinc puddling.
- Holes should be orientated in the same plane as the fabrication.
- Holes **should not** be located in the centre of end plates and connections.
- Holes should be diagonally opposed where possible.

### Hole Size

- Minimum hole size is Ø10mm
- Hole diameters should be at least the same size as the steel thickness.
- Having bigger holes (where feasible) is always better for the galvanizing outcome.

## Handrail Hole Positions

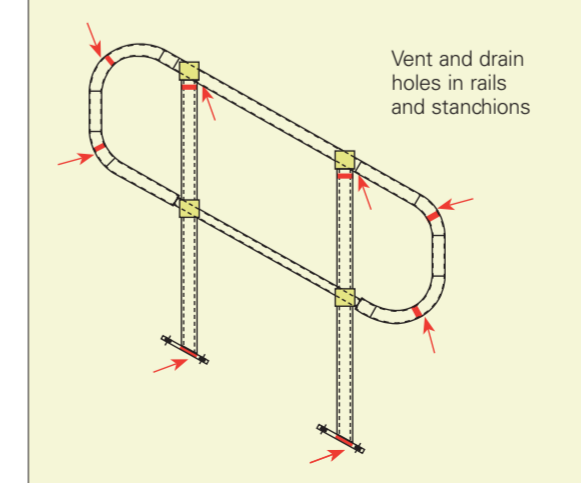

## Designs which will provide the highest quality HDG finish are:

- Modules within a single plane (straight sections).
- Modular designs that can be bolted together on-site.
- Large vent and drain holes in the hollow sections which will allow the zinc to flow freely and air to escape from inside the article.
- Internal venting of the portion of the rail inside the ball of a stanchion is required if the tube runs through the ball.

## Designs which will need special consideration to provide the highest quality HDG finish are:

- Handrails with multiple planes (corner or bent sections) so that some parts of the handrail vent and drain slower than others parts within the same handrail. This can affect available hanging angles due to both vent and drain designs and bath size restrictions which could reduce coating quality.
- Vent and drain holes that are internal so the existence of the holes can't be verified.